

Article number: 586PLL64

Description: Mini Push-in PLL64, angle, M6 hose Ø4

Measures

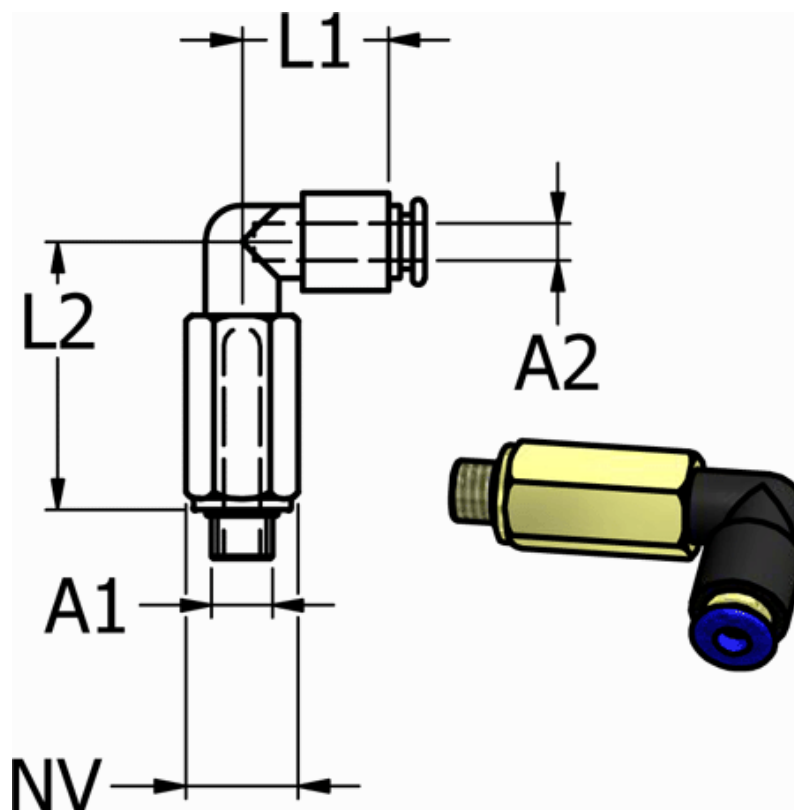

Ext. hose diameter A2 = 4 mm

L1 = 28

L2 = 17.6

NV = 10

Thread A1 = M6